

# 19715-1

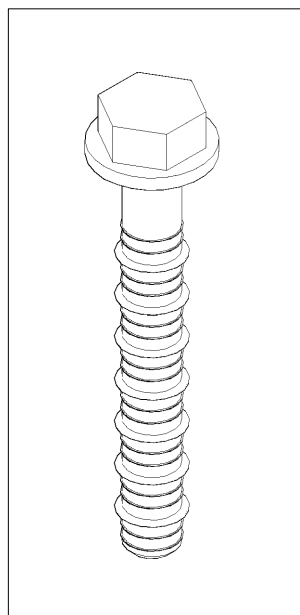

x 4

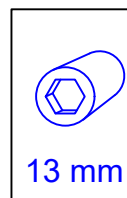
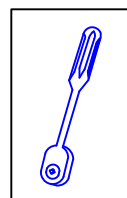
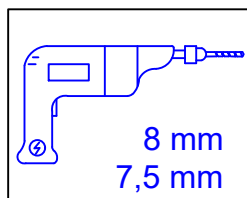
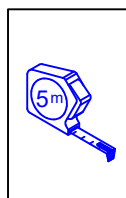
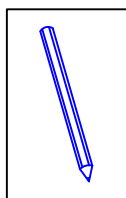
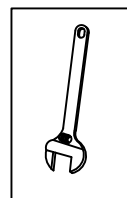

- (DK) Fastgørelse af PLUS cubic stolpefod, composit stolpefod og stålstolpe med fod.  
Montering med beton skrue som også kan anvendes i en trækonstruktion.  
I begge tilfælde skal der forbores og fastskrues med en 13 mm nøgle.

**Beton forbores med Ø8 mm bor. / Træ forbores med Ø7,5 mm bor.**

- (EN) Mounting of PLUS cubic postholder, composite postholder and steel post with feet.  
Mounting with concrete screw which also can be used in a wooden structure.  
In both cases pre-drill and fastend with a 13 mm wrench

**Concrete pre-drill diameter of 8 mm. / Wood pre-drill diameter of 7,5 mm.**

- (DE) Befestigung von Plus Cubic Pfostenfuss, WPC Pfostenfuss und Stahlpfosten mit Fuss.  
Montage mit den Schrauben für Beton, die auch bei Holzkonstruktionen verwendet werden können.  
In beiden Fällen muss vorgebohrt werden. Festschrauben mit Schlüssel Größe 13.

**In Beton muss mit 8 mm vorgebohrt werden  
und in Holz mit 7,5 mm.**

**PLUS**

PLUS A/S  
Ådalen 13B  
DK-6600 Vejen  
phone: +45 7996 3333  
web: www.plus.dk

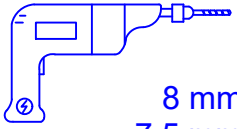
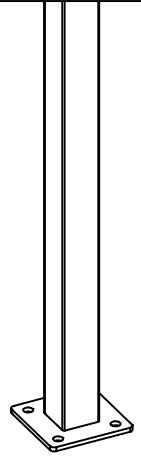
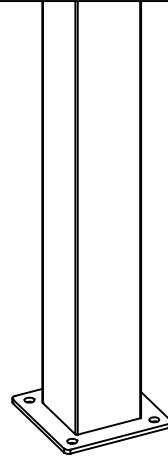
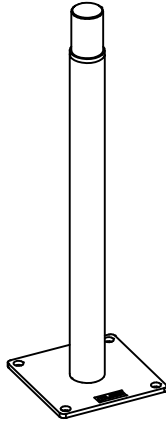
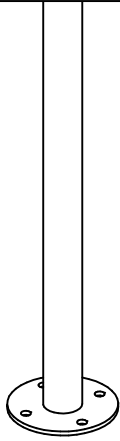
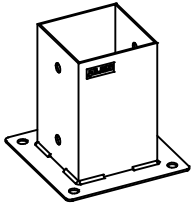

8 mm  
7,5 mm

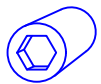
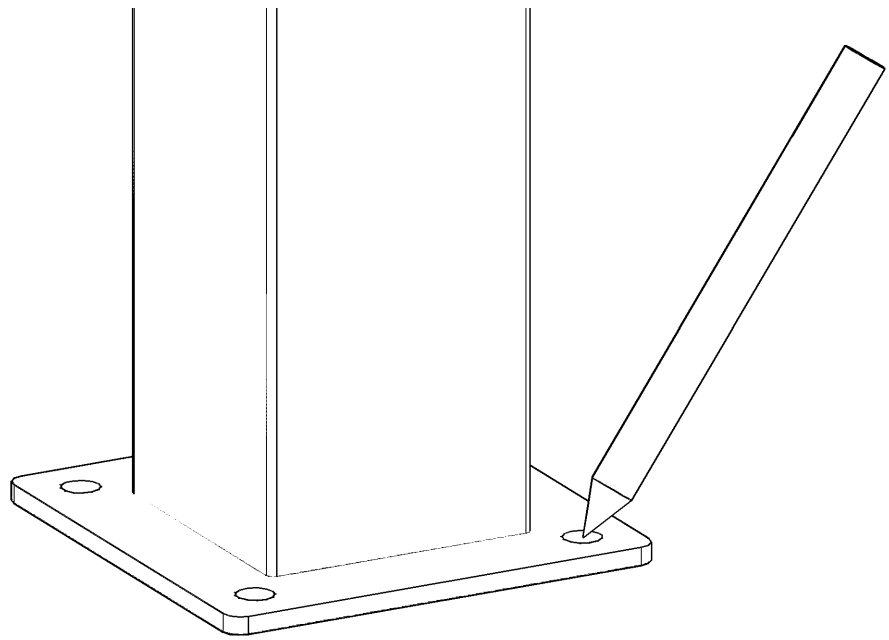

13 mm

